



### MIOL

#### Dik Bağlama Elemanları - Yatay Lamalı tip

Galvaniz kaplı, kırmızı renkte ve yağa mukavim plastik tutma saplı, sertleştirilmiş ve yağlanmış yataklama burçlu. Baskı civatası ve koruyucu lastik başlık ile birlikte komple.

#### Vertical acting toggle clamps with solid arm



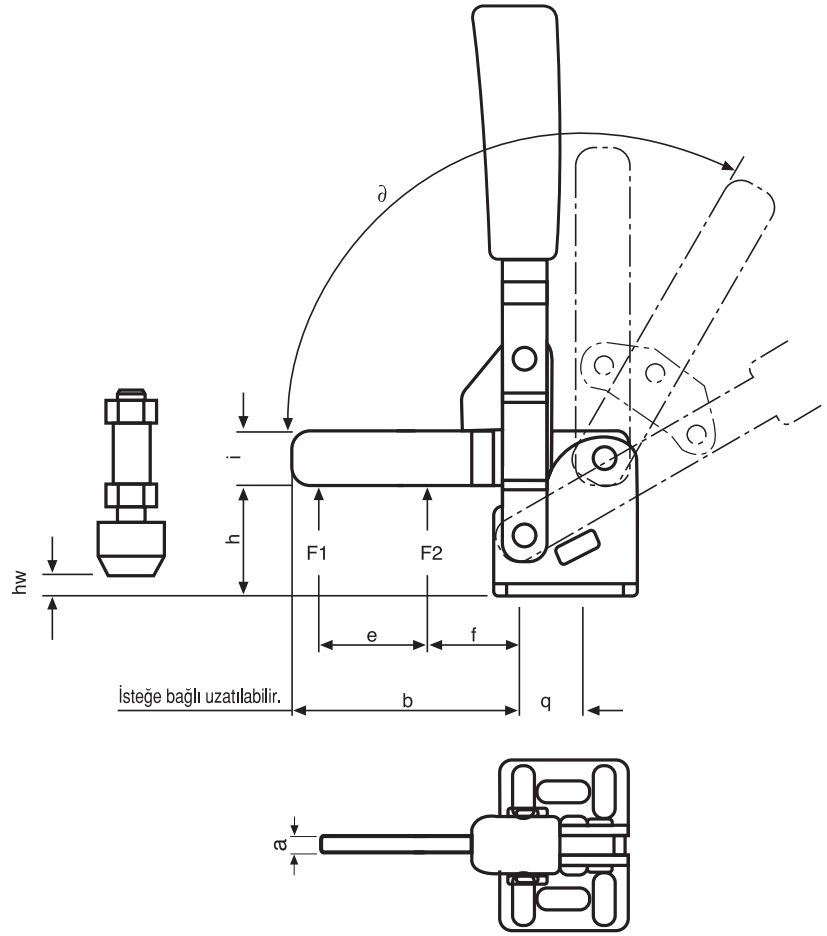

Zinc plated, with red oil resistant plastic handles, bushes case hardened and greased, supplied complete with clamping screw and rubber nose.



boy / size **2-5**

boy / size **3**

boy / size **4**

Boy Size	F1 (kN)	F2 (kN)			hw		
2	1.0	1.2	140	76	-3 ÷ 6	M6 x 35	178
3	1.8	2.5	200	105	0 ÷ 12	M8 x 45	400
4	2.0	3.0	230	140	-8 ÷ 21	M8 x 65	740
5	3.0	5.0	265	190	10 ÷ 34	M12 x 80	1500

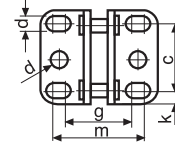
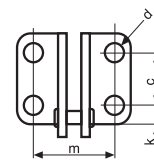
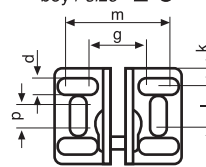

Boy / Size	a	b	c	d	e	f	g	h	i	k	l	m	n	p	q	$\partial$
2	5	51	20	5.3	24	10	23	26	12	6	11	30	26	3	13	100°
3	6	72	20	7	29	27	-	36	18	7.5	-	32	-	-	16	105°
4	8	101	34.5	8.5	61	30	34	48	20	9.25	17	45	-	-	22	105°
5	10	137	45	8.5	88	40	45	55	25	10.5	25	50	45	5	31.5	115°